



Galaxy VX

Highly efficient, scalable, three-phase power protection with flexible operating modes and ECOversion for large facilities, data centers, and business-critical applications.

From 500 kW to 1500 kW N+1
Parallel solutions up to 4000 kW
380 V / 400 V / 415 V / 440 V / 480 V



se.com/ups

Life Is On

Schneider
Electric

Scalable, flexible, high-performance power protection to meet the changing needs of your rapidly expanding business

Galaxy VX is a highly efficient, modular three-phase UPS scalable from 500 to 1500 kW in a single unit that provides high performance, scalability, and flexibility. Its scalability accommodates the changing needs of your rapidly expanding business, and its exceptional performance and abundance of cost-saving features reduce your energy costs and total cost of ownership (TCO). Galaxy VX is the ideal UPS for today's large data centers, cloud and colocation facilities, as well as mission-critical applications.

- Reduces TCO with up to 99% efficient third-party certified Class 1 EConversion operating mode
- Enables on-site UPS expandability with 250 kW power cabinets and the ability to parallel up to four units for capacity or redundancy
- Improves UPS reliability and lifecycle with patented four-level inverter technology
- Optimizes your return on investment, and increases your UPS and energy storage utilization, with dispatchable operation
- Speeds up your deployment time, increases on-site reliability, and reduces start-up costs with Smart Power Test (SPoT) mode
- Compatible with low TCO, high-performance Lithium-ion batteries
- Lowers maintenance and replacement costs with modular architecture



Scale up easily with modular design and high-density footprint

Modular design

The Galaxy VX system scales using 250 kW power cabinets. Power cabinets can be added after initial installation to allow for load growth or increased redundancy.

Expand Galaxy VX from 500 kW up to 1500 kW N+1

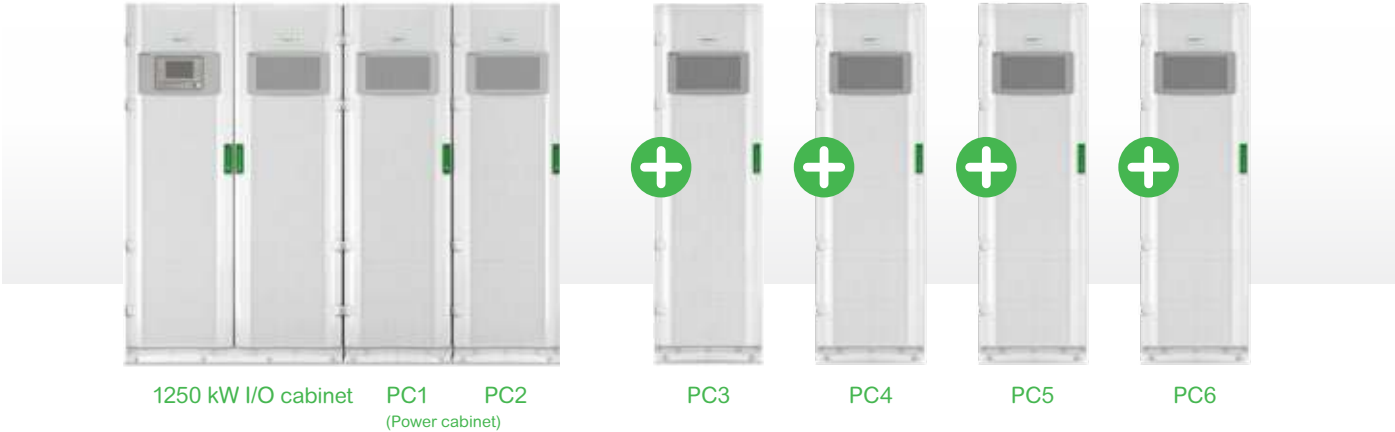

New footprint-optimized 1250 kW input/output (I/O) cabinet supports up to 1250 kW N+1 in a single frame



Inside the Galaxy VX redundant and scalable UPS

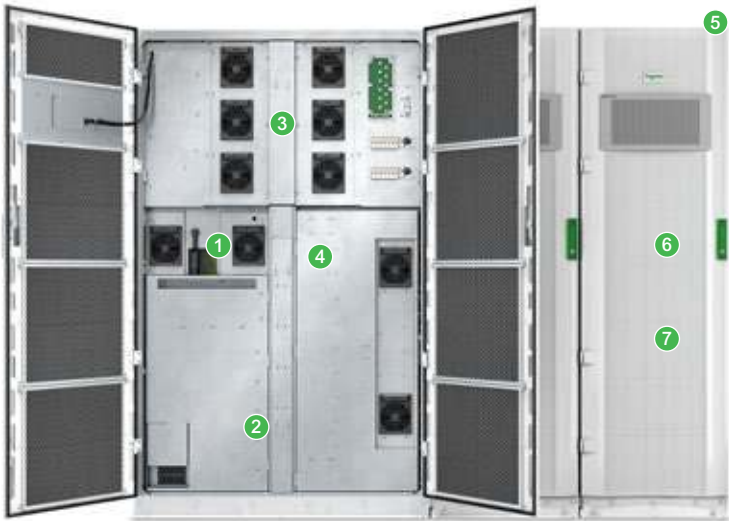

- 1 **Backfeed contactor**
Included in the UPS to meet local electrical codes and increase user safety
- 2 **Redundant power supply**
Included in the I/O cabinet to enhance reliability
- 3 **Static switch**
Fully rated, with front-to-back airflow
- 4 **Main controller / bypass controller redundancy**
If the main controller goes offline, the bypass controller will operate the UPS
- 5 **Fiber optic communication**
Fast and clear internal communication increases system reliability
- 6 **Power modules in power cabinet**
42 kW single phase power block is easy to replace with a low mean time to repair (MTTR)
- 7 **Replaceable fans**
Replace fans while the UPS is online

Best operational efficiency

Reduce your energy bill

Very high efficiency for medium and large data centers and colocation facilities. By using ECOConversion mode, significant savings are achieved every year on your electricity bill.

ECOConversion: an unbeatable combination of power quality and high efficiency

Over \$350,000 in utility and cooling savings per 1 MW load for 10 years of operation



Typically after 3-5 years*, electricity savings = UPS acquisition cost

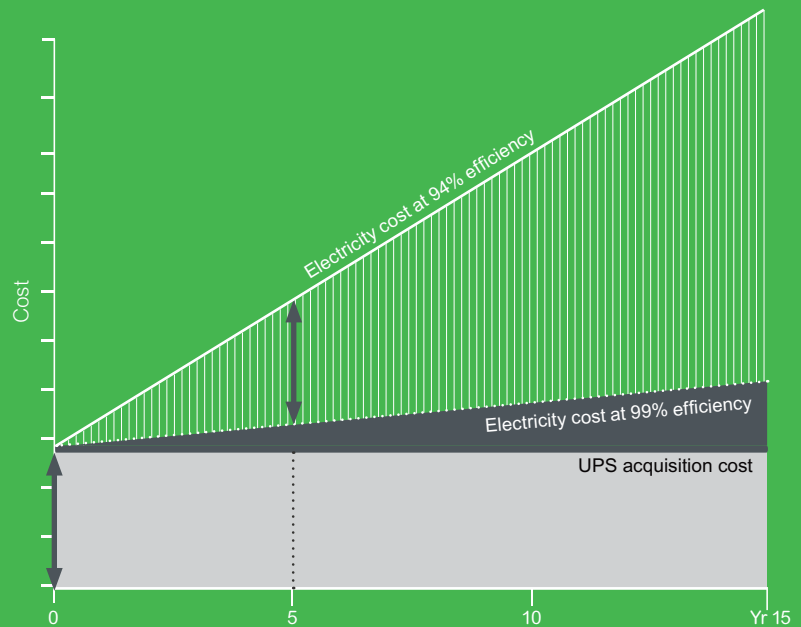

*15 year Galaxy VX Savings in ECOConversion (USD) 2 MW UPS @ 50% load (\$0.10/kWh)

ECOConversion mode

Enjoy the highest energy savings available today without sacrificing load protection – our patented zero-break transfer design offers peace of mind:

- World-class efficiency up to 99%
- Excellent load protection with certified third-party Class 1 performance per IEC 62040-3
- Zero transfer time to continuously-charged batteries or double conversion mode; inverter is always ON and active
- Compliant with IEC 62040-3 Class 1 output performance of UPS standard
- Generator friendly, with no harmonics and input power factor correction
- Programmable scheduling available

How does ECOConversion mode work?

- Bypass input powers the load
- Active inverter supplies power factor correction and harmonic compensation
- Batteries charge continuously
- Patented bypass silicon controlled rectifier (SCR) control prevents input short circuit from affecting critical loads

- Selectable input voltage, frequency, and total harmonic distortion (THDU) windows ensure the UPS operating mode is optimized for site-specific power conditions

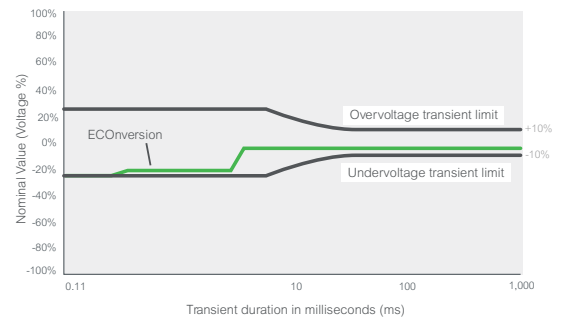

Galaxy VX ECOConversion meets Class 1 of IEC 62040-3: zero-break transfer during power outage.

Calculate your efficiency savings using the Three Phase UPS Efficiency Comparison Calculator: schneider-electric.com/upsefficiencycalculator

Increase reliability, predictability, and performance with advanced Galaxy VX technology

Speed up deployment time, reduce start-up costs, and increase onsite reliability of the UPS operation by using the Smart Power Test (SPoT) mode before connecting your critical load.

SPoT (Smart Power Test)

SPoT enables the field service engineer (FSE) to test the UPS with full capacity current flow through important components and converters, without using a large system input current and without needing a load bank connected to the system or other system modifications.

- Simple, easy, and safe method to test the UPS at full power
- Can be conducted after service, repair, upgrade, or commissioning of UPS installation to verify system is properly installed
- Reduce risk to load and improve product quality
- Significant cost, time, and power savings!

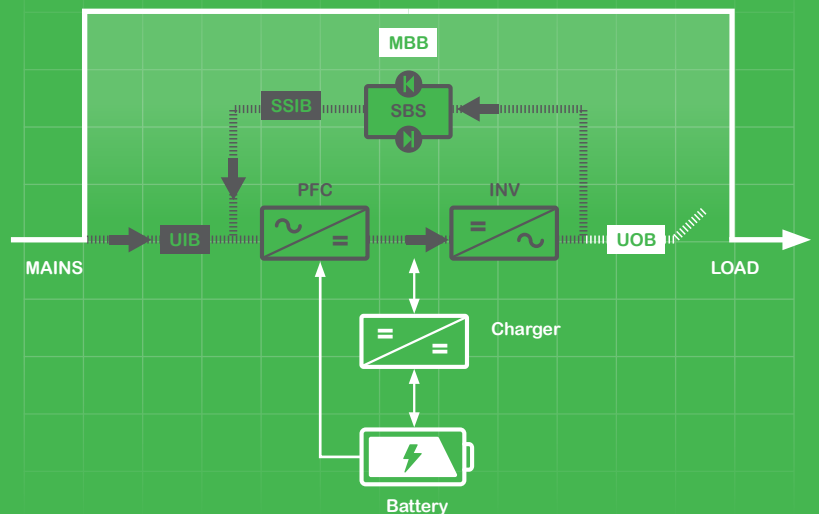

Increase reliability and peace of mind by adding a power module cabinet to achieve N+1 redundancy, or by paralleling up to four UPSs for capacity or redundancy.

Smart paralleling and fault-tolerant design

Galaxy VX inherently redundant design allows for any power cabinet to act as a redundant 250 kW block. Load sharing in parallel is done by matching the percentage output of each system depending on capacity availability. Redundant parallel communication cables increase overall system resiliency.

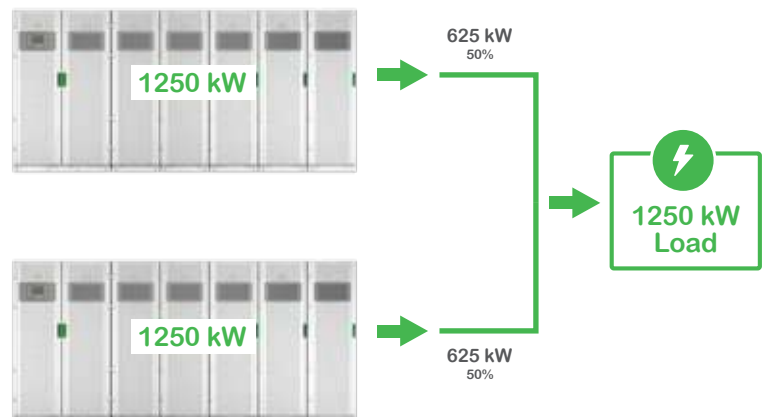

Installation and serviceability

Convenient installation

- Fast and easy installation provided by Schneider Electric field service team
- Power cabinets with casters roll into place
- HMI display includes network communication card
- Install back to back or against a wall
- Compatible with skid and containerized systems
- Secure installation with mechanical anchoring brackets
- OSHPD seismic rating certification

Designed for efficient service

- Front access only for all service and repair tasks
- Field replaceable power modules
- Modular fault-tolerant power blocks reduce mean time to repair



Flexible, optimized, long-life energy storage with Lithium-ion

Galaxy VX seamlessly integrates with the Schneider Electric Lithium-ion energy solution, and directly powers the continuous battery monitoring that delivers improved predictability and manageability.



Benefits of Lithium-ion vs. Lead-acid batteries

50-75% less

footprint. Reduce the secure power footprint so revenue-generating equipment can take its place.

60-70% lighter

weight. Provides flexibility to install on any floor while minimizing structural modification requirements.

30-50% lower

total cost of ownership (TCO). This includes lower cooling costs, upfront capital cost, and other operating expenses.

5x faster

recharge. Full recharge in less than 2 hours.

2x-3x longer

expected life. Reduces the burden and cost of battery replacements. Reduces risks of downtime or load interruption during maintenance.

higher

temperature range. Can operate at hotter temperatures while outlasting VRLA.

To learn more about Lithium-ion battery solutions, visit: www.se.com/li-ion

Dispatchable UPS

Unlock the value of your UPS: Maximize savings, generate revenue, and improve resiliency by dispatching stored battery capacity.

Lithium-ion batteries are increasingly being utilized to provide a variety of valuable grid services and generate steady income streams. With modern data centers leveraging Lithium-ion battery technology, such income streams are also available to data center owners. This added functionality enables quick return on investment while increasing system reliability and providing continuous state of health data.

- **Reduce utility demand charges**
 - Offset peak-load demand by dispatching excess capacity from Lithium-ion batteries
- **Minimize time-of-use tariff charges**
 - Reduce energy consumption during peak hours by load shifting to non-peak hours
- **Increase system reliability**
 - Improves overall performance by cycling batteries to validate their state of health
- **Generate new revenue streams**
 - Create additional revenue by participating in utility programs and electricity markets

To learn more about dispatchable UPS solutions, contact your Schneider Electric sales representative.

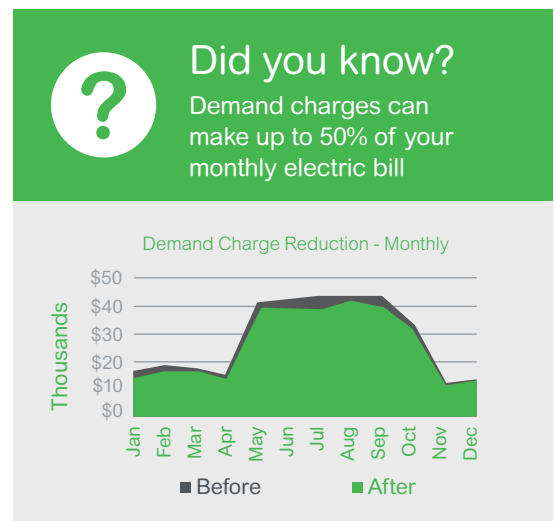

Dispatchable UPS system components



Galaxy VX UPS

- Modular and scalable power solutions for maximum flexibility and reliability
- Ultra-high efficiency and multiple operation modes to reduce energy consumption
- Load protection and peace of mind even when dispatch functions are performed

Lithium-ion batteries

- High cycling capability, increased reliability, and longer life vs lead-acid batteries
- High energy density allows for smaller footprint, translating to space savings
- Improved predictability and manageability via continuous battery monitoring
- Reduced total cost of ownership (TCO) and simplified maintenance

EcoStruxure Microgrid Advisor

- Advanced model predictive control algorithms autonomously enable maximum energy savings while optimizing battery life
- Stay informed of energy usage, savings, and battery reserve via EMA app and Web site
- System reliability via 24-hour advanced automatic default operation schedules
- Cyber-secure platform to protect site and related data from external hacks.
- To learn more about EMA, visit: www.se.com/ema

Visibility and peace of mind

Manage and monitor your Galaxy VX from anywhere, at any time, on any device, thanks to EcoStruxure IT software and services.

EcoStruxure leverages advancements in IoT, mobility, sensing, cloud, analytics, and cybersecurity to deliver innovation at every level. EcoStruxure IT Expert and EcoStruxure Asset Advisor are cloud-based solutions that provide you with enhanced visibility and data-driven insights to optimize data center resiliency and performance.

When it comes to IT critical equipment monitoring, are you more hands-on or hands-off?

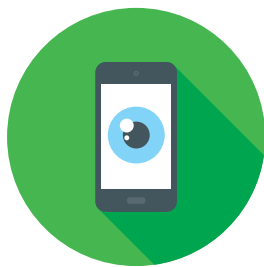

Visibility anywhere, anytime

EcoStruxure IT Expert provides you a hands-on approach with secure, cloud-based monitoring software that synthesizes performance and alert data into proactive recommendations and enables secure, wherever-you-go visibility from any device.

Try it for free for 30 days:

ecostruxureit.com/ecostruxure-it-expert/#trial



24x7 remote monitoring and troubleshooting

EcoStruxure Asset Advisor* for secure power and cooling provides you a hands-off approach with 24x7 remote monitoring service by the Schneider Electric service bureau engineers. We monitor and troubleshoot, you relax.

** Contact your local representative for availability.*

Comprehensive on-site services

Provides optimal system lifetime

Start-up service:

- Commission the installation in accordance with manufacturer's recommendations. Ensure optimal system performance from Day 1.

Schneider Electric-certified installation services

- Expert configuration of your equipment for optimal performance and reliability.

Maintenance services

- Ensure proper care of your mission-critical applications.
- Preventive maintenance and response time upgrades, where available.

Flexible service plans / on-site extended warranty

- Hassle-free system maintenance.
- Improve uptime at a predictable cost.

Technical specifications

Galaxy VX Technical Specs	500 kW to 1500 kW UPS
Topology	On-line double conversion with ECOConversion mode
Nominal Power (kVA)	500 - 1250 kW (1250 kW input/output cabinet) 500 - 1500 kW (1500 kW input/output cabinet)
Technical Power Ratings	500 kW, 625 kW, 750 kW, 800kW, 1000 kW, 1100 kW, 1250 kW, 1500 kW
Parallel capability	Up to 4 units (N+1)
Input	
Rectifier Type	IGBT active rectifier
Nominal Input Voltage	380V / 400V / 415V / 440V / 480V, 3-wire (3PH + PE) or 4-wire (3PH + PE + N) (600V with optional external transformer)
Input Voltage Range	+20% / -15%
Input Connection	Single or dual feed
Input Frequency	50 or 60 Hz nominal (40-70 Hz)
Input Current Total Harmonic Distortion (THDI)	< 3% @ 100% load
Input Power Factor	> 0.99
Walk-in	0 to 300s (configurable)
Short Circuit Withstand Rating	100 kA
Output	
Inverter Type	4 Level IGBT, high efficiency, transformerless
Nominal Output Voltages	380V / 400V / 415V / 440V / 480V, 3-wire (3PH + PE) or 4-wire (3PH + PE + N) (600V with optional external transformer)
Load Power Factor	0.7 leading to 0.5 lagging without UPS derating
Voltage Regulation	+/- 1%
Frequency Regulation	50/60Hz +/- 0.1% (free running)
Overload in Normal Operation (at 40°C)	Continuous up to 110% 10 minutes up to 125% 1 minute up to 150%
Overload in Bypass Operation (at 40°C)	Continuous up to 110% (380V / 400V / 415V / 440V) Continuous up to 125% (480V) 1 minute up to 150% (all voltages)
Output Voltage Distortion (THDU)	<2% at 100% linear load; <3% at 100% nonlinear load
Output Power Factor	1.0 kVA = kW
Efficiency Details	
Double Conversion mode	Up to 96.5%
ECOConversion mode	Up to 99%
Energy Storage Parameters	
Type	Li-Ion, VRLA, Wet Cell, Flywheel
Nominal DC Bus Voltage	480 VDC
Common battery string	Yes (VRLA only)
Communication	
Multilingual Graphics LCD Display	Yes
Compatibility with APC Communication cards	AP9630
Communication Details	Modbus TCP/IP, SNMP, Email Modbus RS-485 (optional)

Technical specifications cont.

Galaxy VX Technical Specs	500 kW to 1500 kW UPS
Mechanical Dimensions	
1250 kW I/O Cabinet (H x W x D)	
500 kW	77.6 x 94.4 x 35.4 in (1970 x 2400 x 900 mm)
625/750 kW	77.6 x 118.1 x 35.4 in (1970 x 3000 x 900 mm)
800/1000 kW	77.6 x 141.6 x 35.4 in (1970 x 3600 x 900 mm)
1100/1250 kW	77.6 x 165.2 x 35.4 in (1970 x 4200 x 900 mm)
1250 kW N+1	77.6 x 188.8 x 35.4 in (1970 x 4800 x 900 mm)
1500 kW I/O Cabinet (H x W x D)	
500kW	77.6 x 126 x 35.4 in (1970 x 3200 x 900 mm)
750kW	77.6 x 149.6 x 35.4 in (1970 x 3800 x 900 mm)
1000 kW	77.6 x 173.2 x 35.4 in (1970 x 4400 x 900 mm)
1250 kW	77.6 x 196.9 x 35.4 in (1970 x 5000 x 900 mm)
1500 kW	77.6 x 220.5 x 35.4 in (1970 x 5600 x 900 mm)
1500 kW N+1	77.6 x 245.1 x 35.4 in (1970 x 6200 x 900 mm)
Standards and Approvals	
Performance and Safety	UL 1778 5th edition, cUL CE, IEC 62040-1 IEC 62040-3 (VFI-SS-111)
EMC Emissions	FCC 47 Part 15 IEC 62040-2
Seismic	OSHDP IBC 2012
Surge	ANSI 62.4/B3
IP level (Ingress Protection)	IP20
Environment	
Operating Temperature	0 – 40° C (32 – 104° F) without derating
Humidity	0 – 95% noncondensing
Elevation / Altitude	1000 m (3333 ft) 100% load without derating
Standard Features	
Soft Start, Walk-in Charger for Compatibility with Gensets	Yes, Adaptive, Configurable 1 to 300s
Cold Start Function (start without mains)	Yes
Emergency Stop (EPO)	No
Frequency Converter	Yes
Backfeed Protection	Yes
Smart Power Test (Spot)	Yes



Life Is On



To learn more about the Galaxy VX UPS, EcoStruxure IT cloud-based DCIM, and EcoStruxure Asset Advisor 24x7 Digital Monitoring Services, contact your Schneider Electric representative or visit se.com/ups

About Schneider Electric At Schneider Electric, we believe access to energy and digital is a basic human right. We empower all to **make the most of their energy and resources**, ensuring **Life Is On** everywhere, for everyone, at every moment. We provide **energy and automation digital** solutions for **efficiency and sustainability**. We combine world-leading energy technologies, real-time automation, software and services into integrated solutions for Homes, Buildings, Data Centers, Infrastructure and Industries. We are committed to unleash the infinite possibilities of an **open, global, innovative community** that is passionate about our **Meaningful Purpose, Inclusive and Empowered** values.

www.se.com

Schneider Electric SE
35 rue Joseph Monier
92500 Rueil Malmaison – France
se.com