



User Manual

English

Smart-UPS™

SUA1000I-IN / SUA1500I-IN

230 VAC

Tower

Uninterruptible Power Supply

Important Safety Information

SAVE THESE INSTRUCTIONS - This manual contains important instructions that should be followed during installation and maintenance of the Smart-UPS and batteries.

Read the instructions carefully to become familiar with the equipment before trying to install, operate, service or maintain it. The following special messages may appear throughout this manual or on the equipment to warn of potential hazards or to call attention to information that clarifies or simplifies a procedure.



The addition of this symbol to a Danger or Warning safety label indicates that an electrical hazard exists which will result in personal injury if the instructions are not followed.



This is the safety alert symbol. It is used to alert you to potential personal injury hazards. Obey all safety messages that follow this symbol to avoid possible injury or death.

DANGER

DANGER indicates a hazardous situation which, if not avoided, will result in death or serious injury.

WARNING

WARNING indicates a hazardous situation which, if not avoided, could result in death or serious injury.

CAUTION

CAUTION indicates a hazardous situation which, if not avoided, could result in minor or moderate injury.

NOTICE

NOTICE is used to address practices not related to physical injury.

Product Handling Guidelines

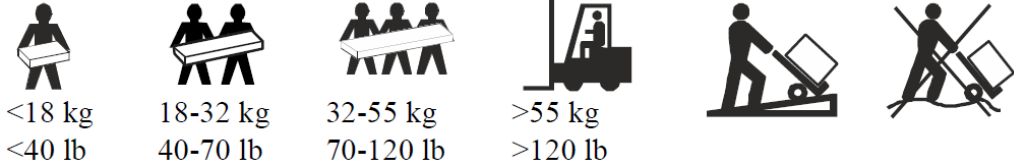

Safety and General Information

Inspect the package contents upon receipt. Notify the carrier and dealer if there is any damage. Read the Safety Guide supplied with this unit before installing the UPS.

- Adhere to all national and local electrical codes.
- All wiring must be performed by a qualified electrician.
- Changes and modifications to this unit not expressly approved by APC could void the warranty.
- This UPS is for indoor use only.
- Do not operate this UPS in direct sunlight, in contact with fluids, or where there is excessive dust or high humidity.
- Do not operate the UPS near open windows or doors.
- Be sure the air vents on the UPS are not blocked. Allow adequate space for proper ventilation. **Note:** Allow 20 cm clearance on both front and rear sides of the UPS.
- Use only the mains and communication cables provided along with the UPS.
- The equipment is heavy. Always practice safe lifting techniques adequate for the weight of the equipment.

Product Description

The APC™ by Schneider Electric Smart-UPS™ is a high performance uninterruptible power supply (UPS). The UPS provides protection for electronic equipment from utility power blackouts, brownouts, sags, and surges, small utility power fluctuations and large disturbances. The UPS also provides battery backup power for connected equipment until utility power returns to acceptable levels or the batteries are fully discharged.

This user manual is available on the APC by Schneider Electric Web site, www.apc.com.

1: INSTALLATION

Package contents

Inspect the UPS upon receipt. Notify the carrier and dealer if there is damage.

The packaging is recyclable; save it for reuse or dispose of it properly.

Check the package contents:

- UPS
- UPS literature kit containing:
 - Product documentation, safety and warranty information
 - Serial and USB communication cables
 - Jumper cable (output cable)
 - Input power cord

Note: The UPS is shipped with the battery disconnected.

Positioning the UPS

NOTICE

RISK OF EQUIPMENT DAMAGE

- UPS must be used indoors only.
- The installation location should be sturdy to withstand the weight of the UPS.
- Do not operate UPS where there is excessive dust or where the temperature or humidity are outside specified limits.

Failure to follow these instructions can result in equipment damage.

The UPS is heavy. Select a location sturdy enough to handle the weight.

Do not operate the UPS where there is excessive dust or the temperature and humidity are outside the specified limits.

PLACEMENT

0°- 40°C (32°-104°F)

0-95% Relative Humidity

2.5cm (1in)



Connecting Equipment and Power to the UPS

SMART-UPS REAR PANEL

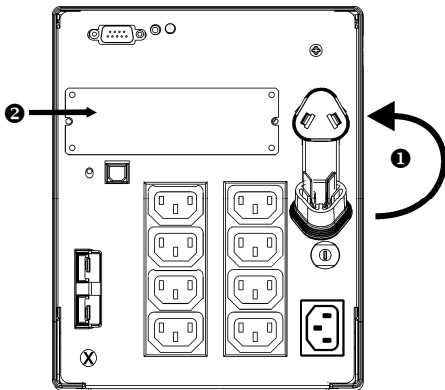

1. **Plug in the battery connector ❶.** The battery connector is located on the rear panel. For battery connection, push the tethered jumper plug into the corresponding port.
2. Connect equipment to the UPS. **Note: Do not connect a laser printer to the UPS. A laser printer draws significantly more power than other types of equipment and may overload the UPS.**
3. Add any optional accessories to the Smart-Slot ❷.
4. Using the power cord (supplied), plug the UPS into a two-pole, three-wire, grounded receptacle only. Avoid using extension cords.
5. Turn on all connected equipment. To use the UPS as a master ON/OFF switch, be sure all connected equipment is switched ON. The equipment will not be powered until the UPS is turned on.
6. To power up the UPS press the  button on the front panel.
 - The UPS charges its battery when it is connected to utility power. The battery charges to 90% capacity during the first three hours of normal operation. **Do not** expect full battery run capability during this initial charge period.
7. For additional computer system security, install PowerChutePlus™ UPS Power Management and Diagnostic Software.

BASIC CONNECTORS

Serial Port



USB Port



Power management software and interface kits can be used with the UPS. **Use only interface kits supplied or approved by APC by Schneider Electric.**

Note: Use the APC by Schneider Electric supplied cable to connect to the Serial Port. **DO NOT** use a standard serial interface cable since it is incompatible with the UPS connector.

Both Serial and USB Ports are provided. They cannot be used simultaneously.

External Battery Pack Connector



XL models: Use the battery pack connector to connect optional external battery pack(s). These units support up to ten external battery packs.

See the APC by Schneider Electric Web site, www.apc.com/support for the correct external battery pack model number for your UPS.

Note: UPS only supports Sealed Maintenance-Free (SMF) batteries.

Ground Screw



The UPS features a ground screw for connecting the ground lead on surge suppression devices such as telephone and network line protectors.

When connecting grounding cable, disconnect the unit from the utility power outlet.

This is a Class A product. In a domestic environment this product may cause radio interference, in which case the user may be required to take corrective actions.

Install PowerChute™ software

To install PCPE, connect the supplied USB cable between the data port on the UPS and to a computer with access to the Web.

On the computer, go to www.apc.com/tools/download. Select Software Upgrades - PowerChute Personal Edition and the appropriate operating system. Follow directions to download the software.

2: OPERATION

SMART-UPS FRONT PANEL

FRONT DISPLAY PANEL

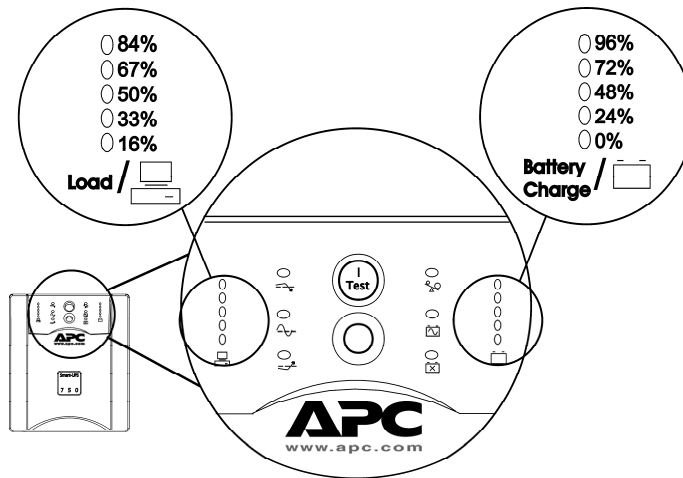

Online



The online LED illuminates when the UPS is supplying utility power to the connected equipment. If the LED is not lit, the UPS is either not turned ON, or is supplying battery power.

AVR Trim



This LED illuminates to indicate the UPS is compensating for a high utility voltage.

AVR Boost



This LED illuminates to indicate the UPS is compensating for a low utility voltage.

On Battery



When the *on battery power* LED is lit the UPS is supplying battery power to the connected equipment. When on battery, the UPS sounds an audible alarm—four beeps every 30 seconds.

Overload



The LED illuminates and the UPS emits a sustained audible alarm tone when an overload condition occurs.

Replace Battery



When the battery self-test does not pass, the UPS emits short beeps for one minute and the *replace battery* LED illuminates. Refer to *Troubleshooting* in this manual.

**Battery
Disconnected**



The *replace battery* LED flashes and short beep is emitted every two seconds to indicate the battery is disconnected.

Automatic Self-Test

The UPS performs a self-test automatically when turned on, and every two weeks thereafter (by default).

During the self-test, the UPS briefly operates the connected equipment on battery.

If the UPS does not pass the self-test, the *replace battery* LED  illuminates and immediately returns to online operation. The connected equipment is not affected when a self-test does not pass. Recharge the battery for 24 hours and perform another self-test. If it does not pass, the battery must be replaced.

Manual Self-Test

Press and hold the  button for a few seconds to initiate the self-test.

FEATURE

FUNCTION

Power On

Press this button to turn on the UPS. (Read on for additional capabilities.)



Power Off

Press this button to turn off the UPS.



On Battery Operation

The Smart-UPS switches to battery operation automatically if the utility power is not available. While running on battery, an audible alarm beeps four times every 30 seconds.

Press the  button (front panel) to silence the UPS audible alarm (for the current audible alarm only). If the utility power does not return, the UPS continues to supply power to the connected equipment until the battery is exhausted.





If PowerChute is not being used you must manually save your files and power down before the UPS turns off.

DETERMINING ON BATTERY RUN TIME





UPS battery life differs based on usage and environment. It is recommended that the battery/batteries be changed once every three years. See the APC by Schneider Electric Web site, www.apc.com, for on battery run times.

3: USER CONFIGURABLE ITEMS

NOTE: SETTINGS ARE MADE THROUGH SUPPLIED POWERCHUTE SOFTWARE OR OPTIONAL SMART SLOT ACCESSORY CARDS.

<i>FUNCTION</i>	<i>FACTORY DEFAULT</i>	<i>USER SELECTABLE CHOICES</i>	<i>DESCRIPTION</i>
Automatic Self-Test	Every 14 days (336 hours)	Every 7 days (168 hours), On Startup Only, No Self-Test	This function sets the interval at which the UPS will execute a self-test. Refer to your software manual for details.
UPS ID	UPS_IDEN	Up to eight characters to define the UPS	Use this field to uniquely identify the UPS, (i.e. server name or location) for network management purposes.
Date of Last Battery Replacement	Manufacture Date	Date of Battery Replacement mm/dd/yy	Reset this date when you replace the battery module.
Minimum Capacity Before Return from Shutdown	0 percent	15, 30, 45, 50, 60, 75, 90 percent	The UPS will charge its batteries to the specified percentage before return from a shutdown.
<p>Voltage Sensitivity</p> <p>The UPS detects and reacts to line voltage distortions by transferring to battery operation to help to protect the connected equipment. Where power quality is poor, the UPS may frequently transfer to battery operation. If the connected equipment can operate normally under such conditions, reduce the sensitivity setting to conserve battery capacity and service life.</p>	 high  medium  low	<p>Brightly lit: UPS is set to <i>high</i> sensitivity (default).</p> <p>Dimly lit: UPS is set to <i>medium</i> sensitivity.</p> <p>Off: Low battery alert interval is about eight minutes.</p>	<p>To change the UPS sensitivity, press the <i>voltage sensitivity</i> button  (rear panel). Use a pointed object (such as a pen) to do so.</p> <p>You can change the sensitivity level through PowerChute software.</p>
Alarm Control	Enable	Mute, Disable	User can mute an ongoing audible alarm or disable all existing audible alarms permanently.

NOTE: SETTINGS ARE MADE THROUGH SUPPLIED POWERCHUTE SOFTWARE OR OPTIONAL SMART SLOT ACCESSORY CARDS.

<i>FUNCTION</i>	<i>FACTORY DEFAULT</i>	<i>USER SELECTABLE CHOICES</i>	<i>DESCRIPTION</i>
Shutdown Delay	90 seconds	0, 180, 270, 360, 450, 540, 630 seconds	Sets the interval between the time when the UPS receives a shutdown command and actual shutdown.
Low Battery Alert. PowerChute interface software provides automatic, unattended shutdown when approximately two minutes (by default) of battery operated run time remains.	 2 min.  5 min.  8 min.	<i>Brightly lit:</i> Low battery alert interval is about two minutes. <i>Dimly lit:</i> Low battery alert interval is about five minutes. <i>Off:</i> Low battery alert interval is about eight minutes. Possible interval settings: 2, 5, 8, 11, 14, 17, 20, 23 minutes.	The low battery alert beeps are continuous when two minutes of run time remain. To change the alert interval default setting, press the <i>voltage sensitivity</i> button (use a pointed object such as a pen to do so), while pressing and holding the  button (front panel).
Synchronized Turn-on Delay	0 seconds	60, 120, 180, 240, 300, 360, 420 seconds	The UPS will wait the specified time after the return of utility power before turn-on (to avoid branch circuit overload).
High Transfer Point	253VAC	257, 261, 265VAC	To avoid unnecessary battery usage, set the high transfer point higher if the utility voltage is chronically high and the connected equipment is known to work under this condition.
Low Transfer Point	208VAC	196, 200, 204VAC	Set the low transfer point lower if the utility voltage is chronically low and the connected equipment can tolerate this condition.
Output Voltage	230VAC	220, 240VAC	Allow the user to select the output voltage.

4: STORAGE, MAINTENANCE, AND TRANSPORTING

Storage

Store the UPS covered and positioned as for proper functioning, in a cool, dry location, with the batteries fully charged.

At -15 to +30 °C (+5 to +86 °F), charge the UPS battery every six months.

At +30 to +45 °C (+86 to +113 °F), charge the UPS battery every three months.

Replacing the Battery Module

CAUTION

RISK OF HYDROGEN SULPHIDE GAS AND EXCESSIVE SMOKE

- Replace the battery at least every 5 years.
- Replace the battery immediately when the UPS indicates battery replacement is necessary.
- Replace battery at the end of its service life.
- Replace batteries with the same number and type of batteries as originally installed in the equipment.
- Replace the battery immediately when the UPS indicates a battery overtemperature condition, or when there is evidence of electrolyte leakage. Power off the UPS, unplug it from the AC input, and disconnect the batteries. Do not operate the UPS until the batteries have been replaced.
- *Replace all battery modules (including the modules in External Battery Packs) which are older than one year, when installing additional battery packs or replacing the battery module(s).

Failure to follow these instructions could result in equipment damage and minor or moderate injury.

*Contact APC by Schneider Electric Customer Support India to determine the age of the installed battery modules.

This UPS has an easy to replace, swappable battery module. See your dealer or contact APC by Schneider Electric at the Web site, www.apc.com/support for information on replacement battery modules.

Note: Once the battery is disconnected, the connected equipment is not protected from power outages.
Be careful during the following steps-the battery module is heavy.

REMOVING THE FRONT BEZEL AND BATTERY MODULE

Step 1

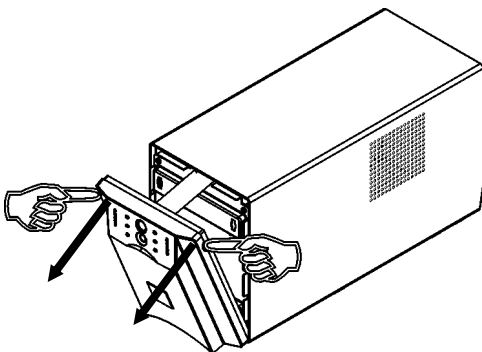

Step 2

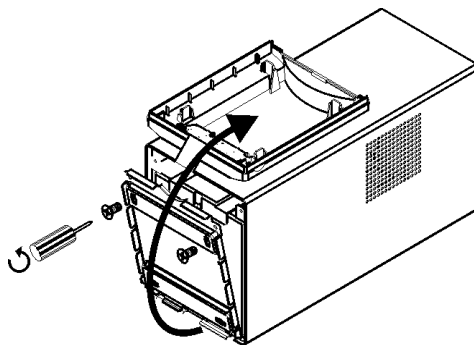

1500VA Model

Step 3

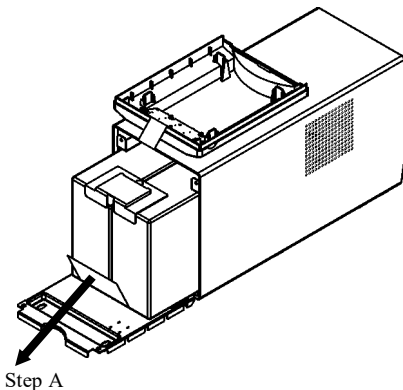

Pull the battery module out of the compartment until the back of the module is flush with the outer edges of the UPS.

Disconnect the battery connector.

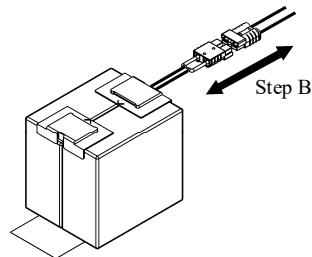

1000VA Model

Step 3

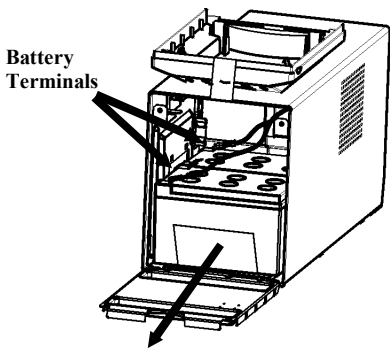

Disconnect the battery cable terminals before removing the battery module from the UPS.

Note: The red cable connects to the red color-coded terminal; the black cable connects to the black color-coded terminal. This will be important during the battery replacement procedure.

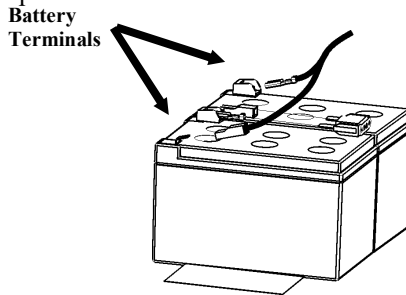

Be sure to deliver the spent battery to a recycling facility or ship it to APC by Schneider Electric in the replacement battery packing material.

REPLACING THE BATTERY MODULE

To replace the battery module, reverse the directions above for *Removing the Front Bezel and Battery Module*.

Disconnecting the Battery for Transport

Note: Always **DISCONNECT THE BATTERY** before shipping the UPS.
The battery may remain in the UPS; it does not have to be removed.

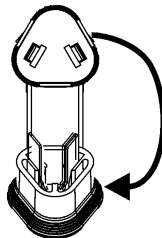

1. Shut down and disconnect any equipment attached to the UPS.
2. Shut down and disconnect the UPS from the power supply.
3. Unplug the battery connector (rear panel).







For shipping instructions and to obtain appropriate packing materials contact APC by Schneider Electric at the Web site, www.apc.com/support/contact.

5: TROUBLESHOOTING

Use the chart below to solve minor Smart-UPS installation and operation problems. Refer to the APC by Schneider Electric Web site, www.apc.com, for assistance with complex UPS problems.

PROBLEM AND POSSIBLE CAUSE	SOLUTION
UPS WILL NOT TURN ON	
<p>Battery not connected properly.</p> <p> button not pushed.</p> <p>UPS not connected to utility power supply.</p> <p>Very low or no utility voltage.</p>	<p></p> <p>Check that the battery connector (rear panel) is fully engaged.</p> <p>Press the  button once to power the UPS and the connected equipment.</p> <p>Check that the power cord from the UPS to the utility power supply is securely connected at both ends.</p> <p>Check the utility power supply to the UPS by plugging in a table lamp. If the light is very dim, have the utility voltage checked.</p>
UPS WILL NOT TURN OFF	
<p>UPS has detected an internal fault.</p>	<p>Do not attempt to use the UPS. Unplug the UPS and have it serviced immediately.</p>
UPS BEEPS OCCASIONALLY	
<p>Normal UPS operation.</p>	<p>None. The UPS is protecting the connected equipment.</p>
UPS DOES NOT PROVIDE EXPECTED BACKUP TIME	
<p>The UPS battery is weak due to a recent outage or is near the end of its service life.</p>	<p>Charge the battery. Batteries require recharging after extended outages. They wear faster when put into service often or when operated at elevated temperatures. If the battery is near the end of its service life, consider replacing the battery even if the <i>replace battery</i> LED is not yet lit.</p>
ALL LEDs ARE LIT AND THE UPS EMITS A CONSTANT BEEPING	
<p>UPS has detected an internal fault.</p>	<p>Do not attempt to use the UPS. Turn the UPS off and have it serviced immediately.</p>
FRONT PANEL LEDs FLASH SEQUENTIALLY	
<p>The UPS has been shut down remotely through software or an optional accessory card.</p>	<p>None. The UPS will restart automatically when utility power returns.</p>
ALL LEDs ARE OFF AND THE UPS IS PLUGGED INTO A WALL OUTLET	
<p>The UPS is shut down and the battery is discharged from an extended outage.</p>	<p>None. The UPS will return to normal operation when the power is restored and the battery has a sufficient charge.</p>

PROBLEM AND POSSIBLE CAUSE	SOLUTION
THE OVERLOAD LED IS LIT AND THE UPS EMITS A SUSTAINED ALARM TONE	
<p>The UPS is overloaded.</p>	<p>The connected equipment exceeds the specified “maximum load” as defined in <i>Specifications</i> at the APC by Schneider Electric Web site, www.apc.com.</p> <p>The audible alarm remains on until the overload is removed. Disconnect nonessential equipment from the UPS to eliminate the overload.</p> <p>The UPS continues to supply power as long as it is online and the circuit breaker does not trip; the UPS will not provide power from batteries in the event of a utility voltage interruption.</p> <p>If a continuous overload occurs while the UPS is on battery, the unit turns off output in order to protect the UPS from possible damage.</p>
THE REPLACE BATTERY LED IS LIT	
<p>Replace Battery LED flashes and short beep is emitted every two seconds to indicate the battery is disconnected.</p> <p>Weak battery.</p> <p>Battery self-test has not passed.</p>	<p>Check that the battery connectors are fully engaged.</p> <p>Allow the battery to recharge for 24 hours. Then, perform a self-test. If the problem persists after recharging, replace the battery.</p> <p>The UPS emits short beeps for one minute and the <i>replace battery</i> LED illuminates. The UPS repeats the audible alarm every five hours. Perform the self-test procedure after the battery has charged for 24 hours to confirm the <i>replace battery</i> condition. The audible alarm stops and the LED clears if the battery passes the self-test.</p>
THE INPUT CIRCUIT BREAKER TRIPS	
<p>The plunger on the circuit breaker (located above the input cable connection) pops out.</p> 	<p>Reduce the load on the UPS by unplugging equipment and press the plunger in.</p>
AVR BOOST OR AVR TRIM LEDs LIGHT	
<p>AVR Boost or Trim LEDs light</p> <p>Your system is experiencing excessive periods of low or high voltage.</p>	<p>Have qualified service personnel check your facility for electrical problems. If the problem continues, contact the utility company for further assistance.</p>
UPS OPERATES ON BATTERY ALTHOUGH NORMAL LINE VOLTAGE EXISTS	
<p>UPS input circuit breaker tripped.</p> <p>Very high, low, or distorted line voltage. Inexpensive fuel powered generators can distort the voltage.</p>	<p>Reduce the load on the UPS by unplugging equipment and resetting the circuit breaker (on the back of UPS) by pressing the plunger in.</p> <p>Move the UPS to a different outlet on a different circuit. Test the input voltage with the utility voltage display (see below). If acceptable to the connected equipment, reduce the UPS sensitivity.</p>

PROBLEM AND POSSIBLE CAUSE	SOLUTION
BATTERY CHARGE AND BATTERY LOAD LEDs FLASH SIMULTANEOUSLY	
<p>UPS has shutdown.</p> <p>The internal temperature of the UPS has exceeded the allowable threshold for operation.</p>	<p>Check that the room temperature is within the specified limits for operation.</p> <p>Check that the UPS is properly installed allowing for adequate ventilation.</p> <p>Allow the UPS to cool down. Restart the UPS. If the problem continues contact APC by Schneider Electric at, www.apc.com/supoport.</p>
DIAGNOSTIC UTILITY VOLTAGE FEATURE	
<p>Utility Voltage</p> <p>0 266 0 248 0 229 0 210 0 191</p> 	<p>The UPS has a diagnostic feature that displays the utility voltage. Plug the UPS into the normal utility power.</p> <p>Press and hold the  button to view the utility voltage bar graph display. After a few seconds the five-LED, Battery Charge, , display on the right of the front panel shows the utility input voltage.</p> <p>Refer to the figure at left for the voltage reading (values are not listed on the UPS).</p> <p>The display indicates the voltage is between the displayed value on the list and the next higher value.</p> <p>Three LEDs light, indicating utility voltage within the normal range.</p> <p>If no LEDs are lit and the UPS is plugged into a working utility power outlet, the line voltage is extremely low.</p> <p>If all five LEDs are lit, the line voltage is extremely high and should be checked by an electrician.</p>
Note:	The UPS starts a self-test as part of this procedure. The self-test does not affect the voltage display.

6: SERVICE

If the unit requires service, do not return it to the dealer. Follow these steps:

1. Review the Troubleshooting section of the manual to eliminate common problems.
2. If the problem persists, contact APC by Schneider Electric Customer Support.
 - Note the model number and serial number and the date of purchase. The model and serial numbers are located on the rear panel of the unit and are available through the LCD display on select models.
 - Call APC by Schneider Electric Customer Support and a technician will attempt to solve the problem over the phone. If this is not possible, the technician will issue a Service Request Number.
 - If the unit is under warranty, the repairs are free.
3. An Authorised Service Representative will visit your location and try to resolve the issue.

7: WARRANTY INFORMATION

Two Year Limited Factory Warranty

Schneider Electric IT Business India Private Ltd. (SEITBIPL), warrants its products to be free from defects in materials and workmanship for a period of two (2) years from the date of purchase. The SEITBIPL obligation under this warranty is limited to repairing or replacing, at its own sole option, any such defective products or parts thereof. Repair or replacement of a defective product or part thereof does not extend the original warranty period.

This warranty applies only to the original purchaser who must have properly registered the product within 10 days of purchase. Products may be registered online at warranty.apc.com or by mailing in the completed warranty registration card that is included with the documentation.

SEITBIPL shall not be liable under the warranty if its testing and examination disclose that the alleged defect in the product does not exist or was caused by end user's or any third person's misuse, negligence, improper installation, testing, operation or use of the product contrary to SEITBIPL's recommendations or specifications. Further, SEITBIPL shall not be liable for defects resulting from: 1) unauthorized attempts to repair or modify the product, 2) incorrect or inadequate electrical voltage or connection, 3) inappropriate on site operation conditions, 4) Acts of God, 5) exposure to the elements, 6) theft. In no event shall SEITBIPL have any liability under this warranty for any product where the serial number has been altered, defaced, or removed, 7) normal wear resulting from frequent use.

EXCEPT AS SET FORTH ABOVE, THERE ARE NO WARRANTIES, EXPRESS OR IMPLIED, BY OPERATION OF LAW OR OTHERWISE, APPLICABLE TO PRODUCTS SOLD, SERVICED OR FURNISHED UNDER THIS AGREEMENT OR IN CONNECTION HEREWITH.

SEITBIPL DISCLAIMS ALL IMPLIED WARRANTIES OF MERCHANTABILITY, SATISFACTION AND FITNESS FOR A PARTICULAR PURPOSE.

SEITBIPL EXPRESS WARRANTIES WILL NOT BE ENLARGED, DIMINISHED, OR AFFECTED BY AND NO OBLIGATION OR LIABILITY WILL ARISE OUT OF, SEITBIPL'S RENDERING OF TECHNICAL OR OTHER ADVICE OR SERVICE IN CONNECTION WITH THE PRODUCTS.

THE FOREGOING WARRANTIES AND REMEDIES ARE EXCLUSIVE AND IN LIEU OF ALL OTHER WARRANTIES AND REMEDIES. THE WARRANTIES SET FORTH ABOVE CONSTITUTE SEITBIPL'S SOLE LIABILITY AND PURCHASER'S EXCLUSIVE REMEDY FOR ANY BREACH OF SUCH WARRANTIES. SEITBIPL WARRANTIES EXTEND ONLY TO ORIGINAL PURCHASER AND ARE NOT EXTENDED TO ANY THIRD PARTIES.

IN NO EVENT SHALL SEITBIPL, ITS OFFICERS, DIRECTORS, AFFILIATES OR EMPLOYEES BE LIABLE FOR ANY FORM OF INDIRECT, SPECIAL, CONSEQUENTIAL OR PUNITIVE DAMAGES, ARISING OUT OF THE USE, SERVICE OR INSTALLATION OF THE PRODUCTS, WHETHER SUCH DAMAGES ARISE IN CONTRACT OR TORT, IRRESPECTIVE OF FAULT, NEGLIGENCE OR STRICT LIABILITY OR WHETHER SEITBIPL HAS BEEN ADVISED IN ADVANCE OF THE POSSIBILITY OF SUCH DAMAGES. SPECIFICALLY, SEITBIPL IS NOT LIABLE FOR ANY COSTS, SUCH AS LOST PROFITS OR REVENUE, WHETHER DIRECT OR INDIRECT, LOSS OF EQUIPMENT, LOSS OF USE OF EQUIPMENT, LOSS OF SOFTWARE, LOSS OF DATA, COSTS OF SUBSTITUANTS, CLAIMS BY THIRD PARTIES, OR OTHERWISE.

To obtain service under warranty you must call customer support. Customers with warranty claims issues may access the SEITBIPL worldwide customer support network through the SEITBIPL Web site: support.apc.com. Select your country from the country selection drop down menu. Open the Support tab at the top of the web page to obtain information for customer support in your region. Refer to the product user manual for more information on how to contact customer support.

APC by Schneider Electric Customer Support India

Internet	http://www.apc.com/support
Toll Free	18001030011/18004194272
E-mail	indiainfo@schneider-electric.com

© 2019 APC by Schneider Electric. APC, the APC logo, PowerChute and Smart-UPS are owned by Schneider Electric Industries S.A.S. or their affiliated companies. All other trademarks are property of their respective owners.